

SPECIFICATION

DWG

PRODUCT NO

ML25

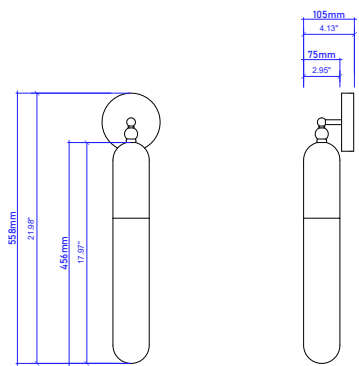
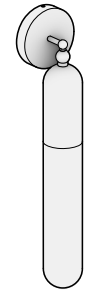

Candela Cylinder Sconce

Type:	Wall Sconce
Style:	Mid-century modern minimalism meets organic
Globe type:	LED DU10
Voltage:	110V-220V compatible
Wattage:	5W
Environment:	Indoor
Installation:	Hard Wired Wall Sconce

Dimensions & Specifications
 Alabaster Tube: 3" diameter (7.5 cm).

Voltage: 110V-220V compatible

Installation: Hardwired; professional mounting advised for secure placement.

Features
 Handcrafted Uniqueness: Each marble is hand-selected for its veining - no two sconces are alike.

Care Instructions
 Marble Base: Wipe gently with a dry microfiber cloth; avoid water or chemicals.

Sealed Stone: Treated with a non-toxic sealant to protect against dust and moisture.

INSTALLATION

STEP 1

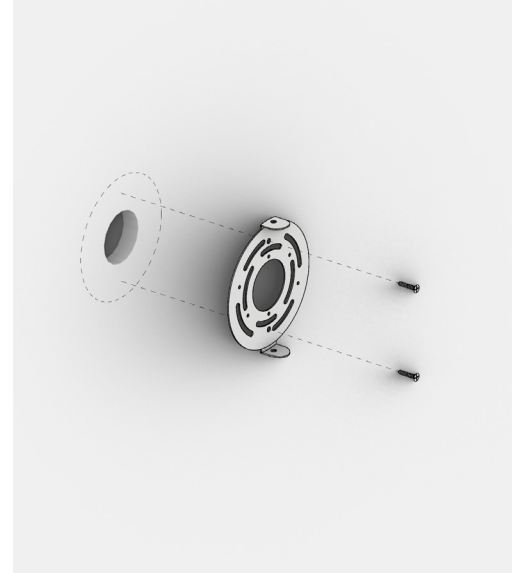

Locate & Mark

Mount the Metal Backplate (Fig. 1): Position the metal mounting plate on the wall and mark the hole locations. Secure the plate firmly to the wall using screws. (Note: Hole positions may vary depending on the specific light combination.)

STEP 2

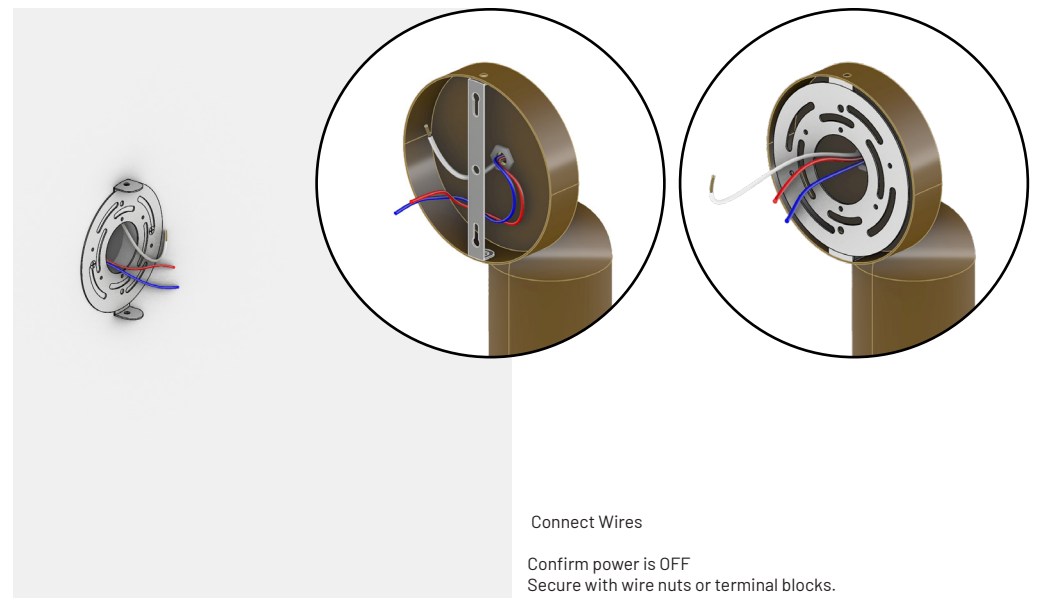

Connect Wires

Confirm power is OFF
 Secure with wire nuts or terminal blocks.

INSTALLATION

STEP 3

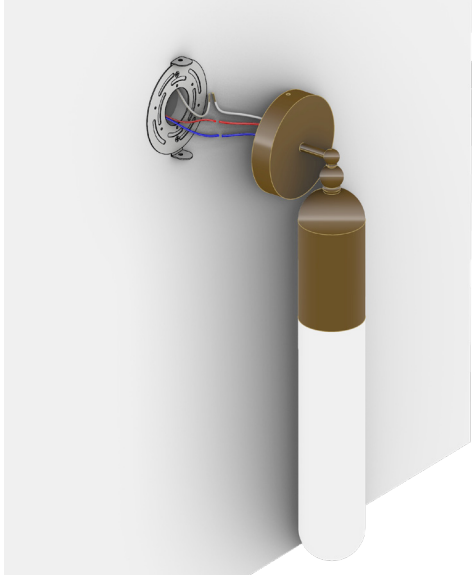

Wiring and Mounting the Base

Connect the wires from the LED cores to the main power supply wires extending from the wall. Neatly tuck the connected wires inside the cavity of the brass base.

INSTALLATION

STEP 5

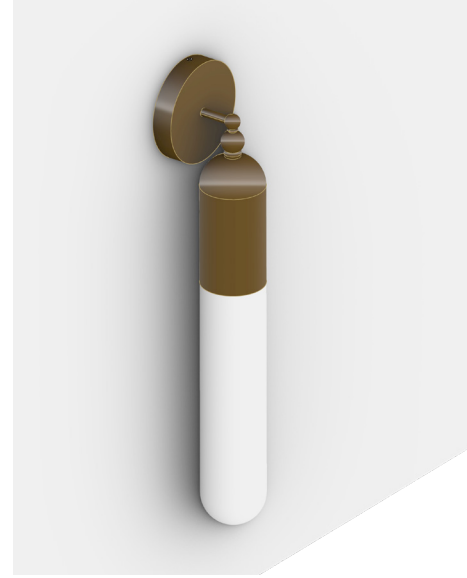

Restore Power & Inspect

Turn power back on at the breaker.
Test the light. Check for flickering, unusual sounds, or heat.
If issues occur, immediately turn off power, recheck connections.

STEP 4

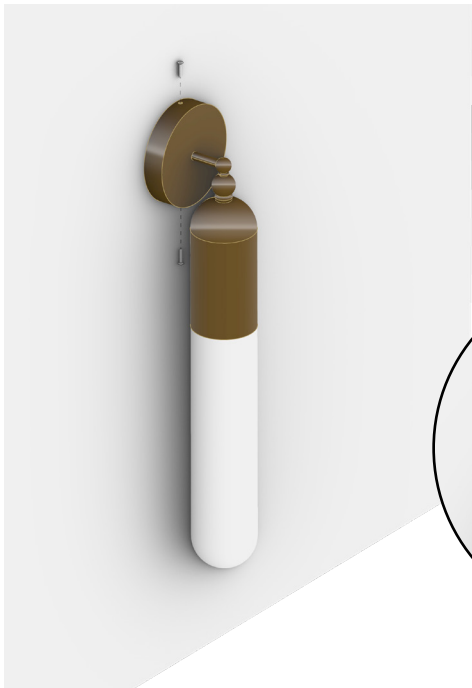

Next, mount the brass base onto the metal backplate and secure it tightly.

